

Site Amenities

BY SUPERIOR RECREATIONAL PRODUCTS



Model #
B4ACS

 **SUPERIOR**[®]
RECREATIONAL PRODUCTS
A **PLAYCORE** Company

HARDWARE

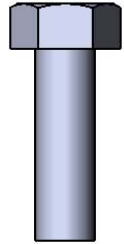

5/16" x 1"
Machine Bolt

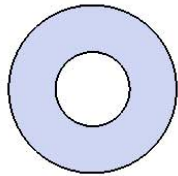

5/16" Washer

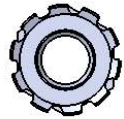

5/16" Kep Nut

TOOLS REQUIRED

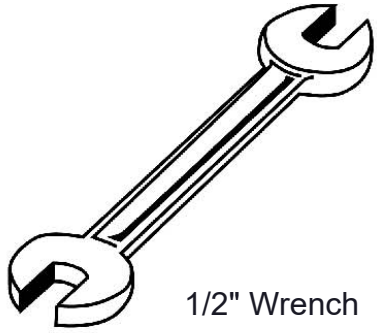

1/2" Wrench

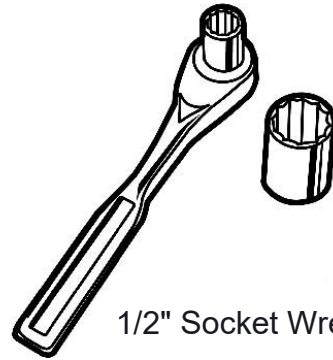

1/2" Socket Wrench

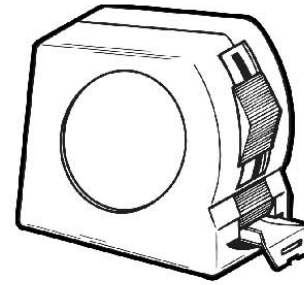

Tape Measure

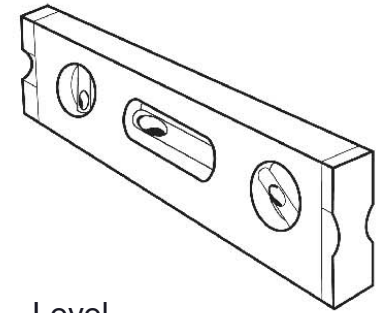

Level

PRODUCT SPECIFICATIONS

B4ACS ACADIA INGROUND MOUNT BENCH WITHOUT BACK

Seat: Seat shall be made from 1-5/8" OD x 13ga steel tube and 1/4" x 4" flat steel plate. The ends shall be 1/4" thick steel plate. Electrically MIG welded.

Coating: Steel is sandblasted to near white condition. Coated with zinc rich epoxy primer and top coated with electrostatic powder coat, oven cured.

Frame: 2-3/8" O.D. x 12 gauge pre-galvanized structural steel tubing. Seat/back support is bent over a mandrel through the bend radius producing a wrinkle free bend. Tube ends are pre-galvanized steel capped. Seat mounting points are 7 gauge x 1-1/2" die stamped steel flat bar. A 4" x 12" steel plate makes up the surface mount footing. The inground mount shall be made from 1-5/8" O.D. x 13 gauge tubing and a 4" x 12" steel plate with 5/16" carriage bolts. All electrically MIG welded.

Frame Coating: Steel is sandblasted to near white condition. Coated with zinc rich epoxy primer and top coated with electrostatic powder coat, oven cured.

Hardware: All stainless steel hardware fasteners.

Dimensions: 4' inground mount bench without back. Seat is 12-3/16" wide x 48" long. Seat height is 18-1/4". Total depth of bench is 21-3/16". Total height of bench is 36-1/2".

COMPONENTS

Attach the 4' Seat and Inground Mounts to the legs using specified hardware.

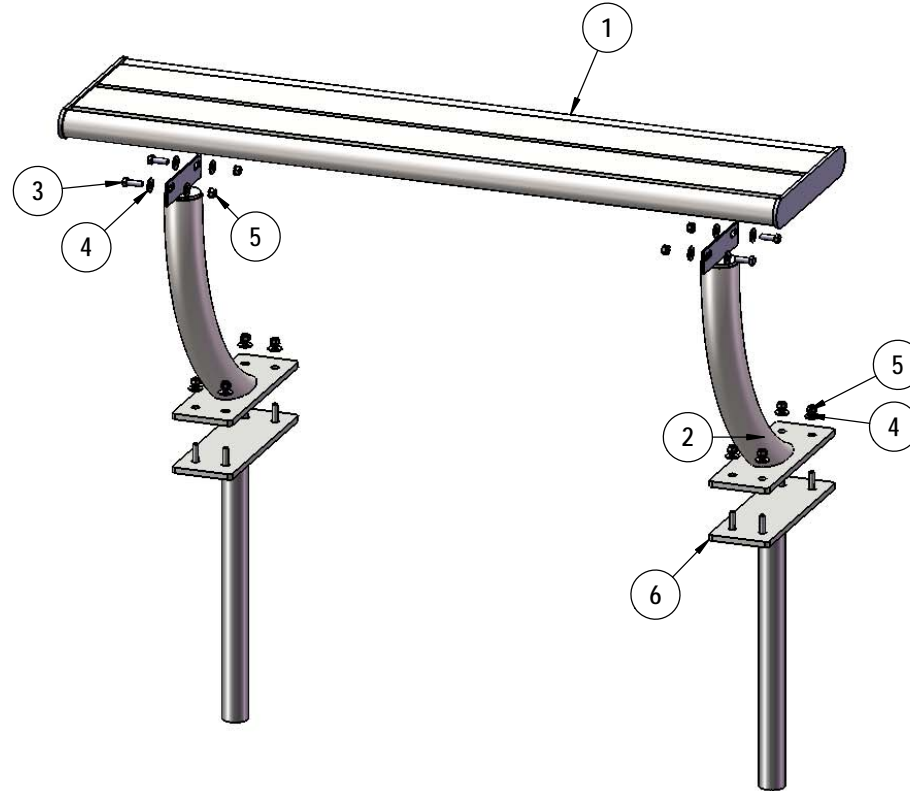

ITEM NO.	PartNo	DESCRIPTION	QTY
1	01-01-0691	Hartford 4' Seat/Back Plank	1
2	01-01-0684	Hartford Series Without back Leg - welded	2
3	33-05-0029	5/16" x 1" Machine Bolt (SS)	4
4	33-02-0007	5/16" SS Washer	16
5	33-03-0012	5/16" Kep Nut (SS)	12
6	01-01-0693	Hartford Inground Footer	2

FOOTINGS

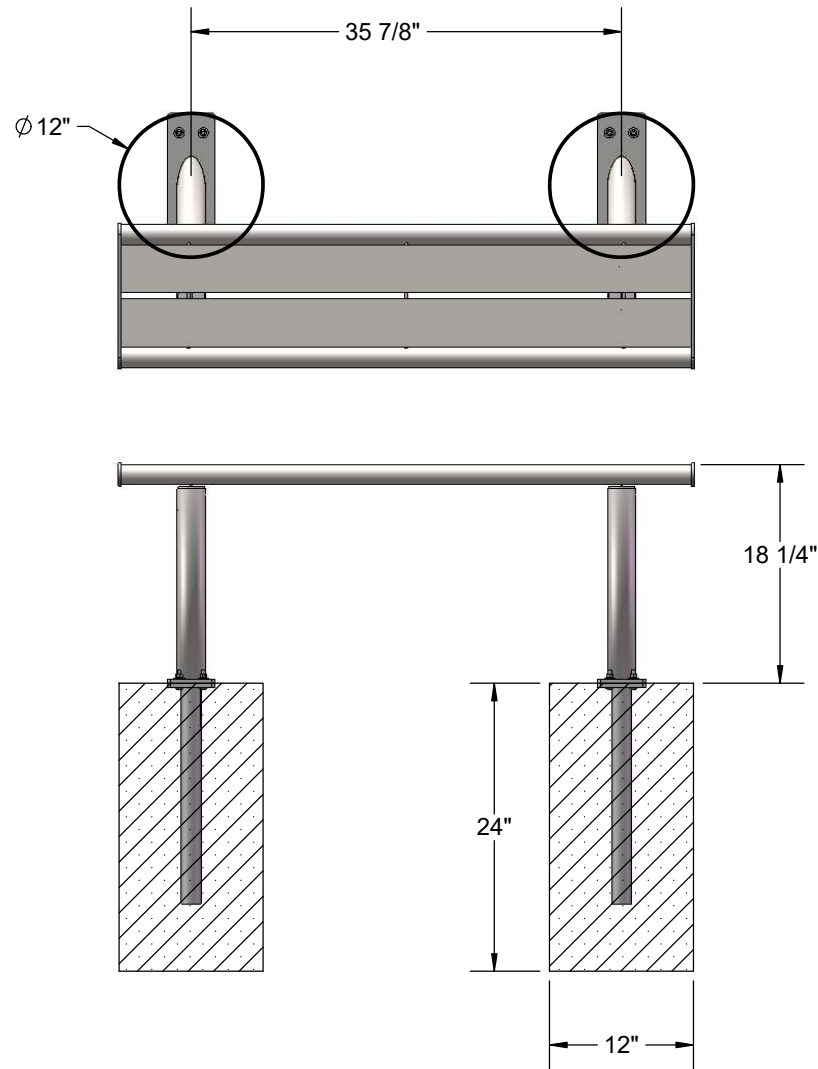

Estimated Required Concrete:
11- 50lb Bags on Concrete Mix

OVERALL DIMENSIONS

