

Site Amenities

BY SUPERIOR RECREATIONAL PRODUCTS



Model #
B4BY-IP-ARM

 **SUPERIOR**[®]
RECREATIONAL PRODUCTS
A **PLAYCORE** Company

HARDWARE



5/16" x 1" Lag Bolt

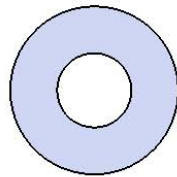

5/16" Flat Washer

PRODUCT SPECIFICATIONS

B4BY-IP-ARM BRYCE BENCH WITHOUT BACK WITH ARMREST

Seats: Seat is made from 1-1/4" x 6" Ipe wood. Reinforced with 7 gauge thick support ribs. Legs are fabricated from 3/4" steel plate with 7 gauge attachment plates. Mounting plates shall be made from 7 gauge steel. All electrically MIG welded.

Coating: Steel is sandblasted to near white condition. Coated with zinc rich epoxy primer and top coated with electrostatic powder coat, oven cured. Ipe wood is sealed on each end to prevent splitting and stained with a wood finish.

Hardware: Hardware shall be stainless steel.

Dimensions: 4' portable/surface mount bench without back with armrest. Seats are 23-9/16" wide x 48" long. Seat height is 17-3/4" from the ground to the top of the seat. The overall dimensions are 49-3/4" x 29-5/16" x 26"

Recommended Surface Mount Hardware: 3/8" x 3-1/2" Concrete Expansion Anchor Bolts (Not Included)

IPE Wood Care and Maintenance to be applied twice a year.

Step 1.) Wash boards with a deck cleaner or IPE cleaner.

Step 2.) After boards are dry, Lightly sand and dust off boards. Before applying stain be sure wood is dry and free of sawdust or dirt.

Step 3.) Apply a new coat of stain per manufacturer's recommendations. We recommend using Penofin© Hardwood Formula.

OVERALL DIMENSIONS

Attach the Ipe Wood Planks to the Endframes and the Attachment Plate using the specified hardware.

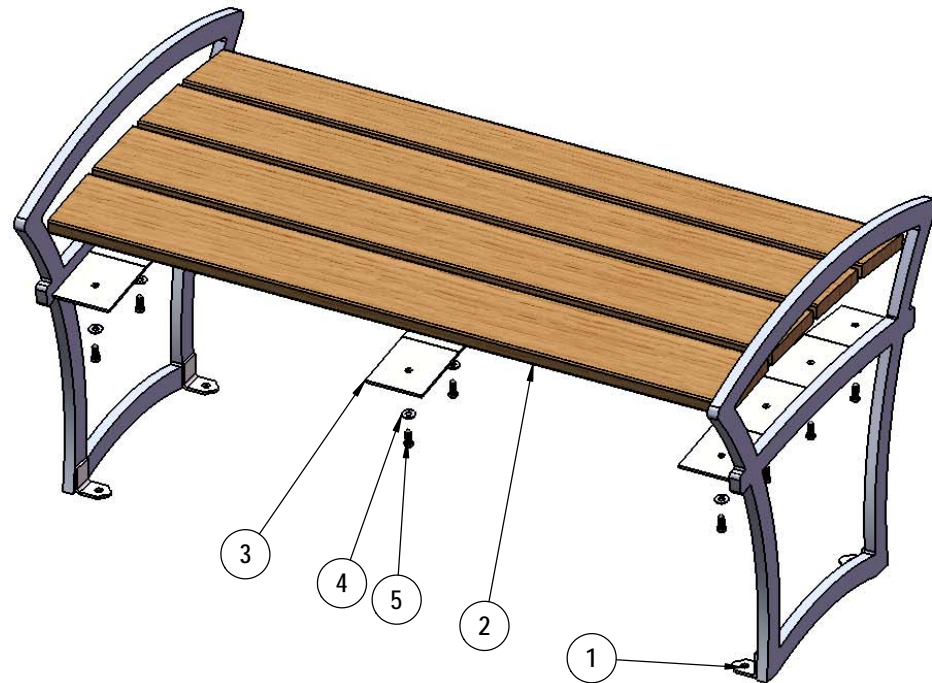

WARNING: Overtightening of lag bolts can cause damage to lumber.

ITEM NO.	PartNo	DESCRIPTION	QTY
1	01-01-0658	madison w/armrest w/out back endframe wood-welded	2
2	01-01-0643	5/4" x 6" x 4' long ipe bench plank	4
3	01-01-0619	madison w/out back wood attachment plate	1
4	33-02-0007	5/16" SS Washer	12
5	33-05-0067	5/16" x 1" lag bolt, SS	12

OVERALL DIMENSIONS

