

Site Amenities

BY SUPERIOR RECREATIONAL PRODUCTS

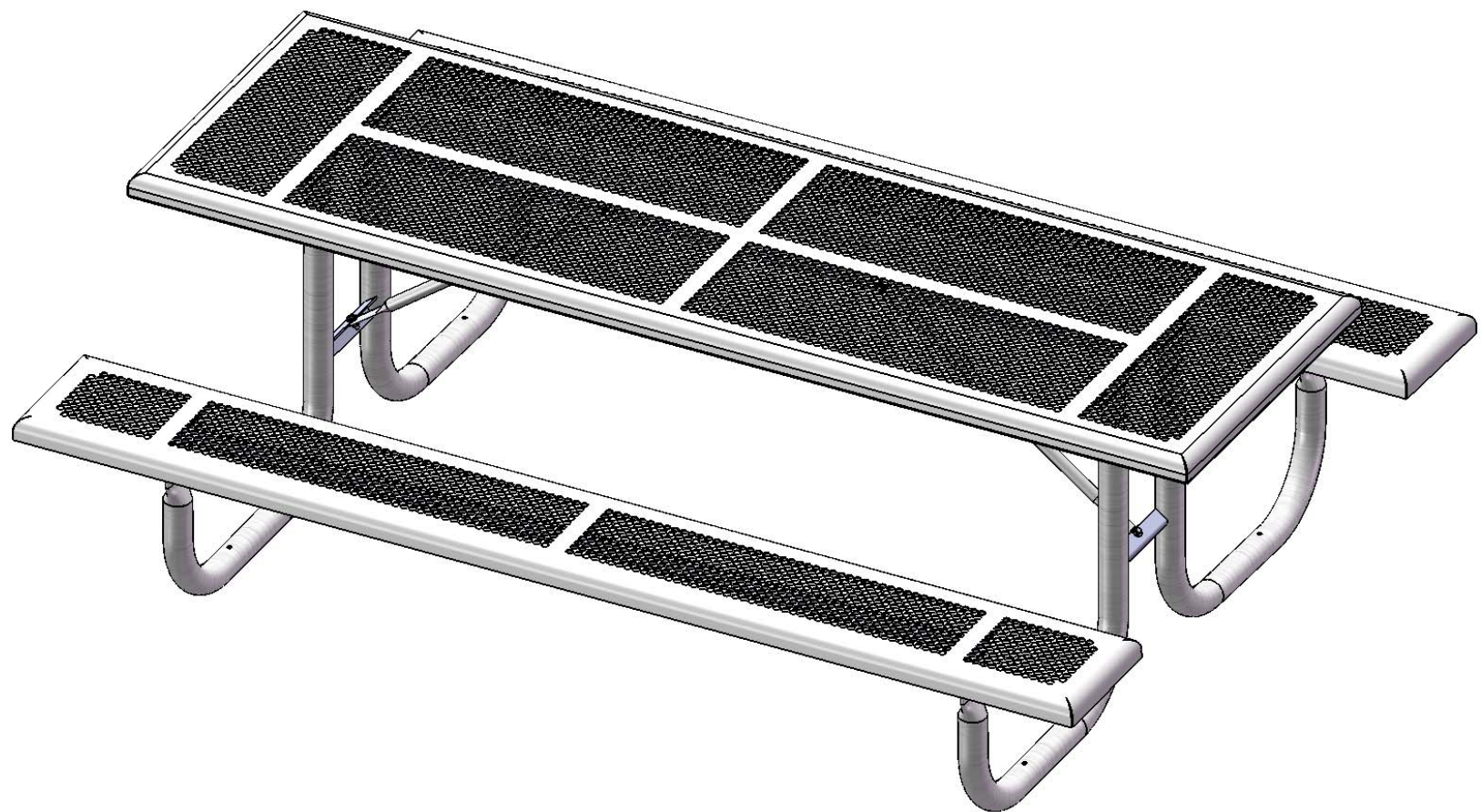

Model #
T8PERF

 **SUPERIOR**[®]
RECREATIONAL PRODUCTS
A **PLAYCORE** Company

HARDWARE

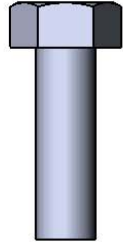

5/16" x 1"
Machine Bolt

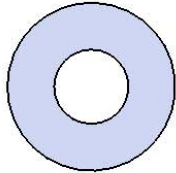

5/16" Washer

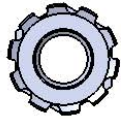

5/16" Kep Nut

PRODUCT SPECIFICATIONS

T8PERF 8' PORTABLE PICNIC TABLE WALK-THROUGH DESIGN

Top & Seats: Top and seats shall have a 1 1/2" radius edge, fabricated from a 14ga plate. Holes are precision punched at 5/8" diameter. 7 gauge x 1-1/2" flat bar center support and mounting bracket understructure. Electrically MIG welded.

Coating: Oven fused functionalized polyethylene copolymer-based thermoplastic. Fluidized bed coating application with superior mechanical performance, impact resistance and UV-stability.

Frame: 2-3/8" O.D. x 12 gauge pre-galvanized structural steel tubing. Cross braces 1" O.D. x 16 gauge pre-galvanized structural steel tubing. Brace attachment points 1-1/2"x1-1/2"x3/16" steel angle. Seat and top mounting points 7 gauge x 1-1/2" die stamped steel flat bar. Legs are bent over a mandrel through the bend radius producing a wrinkle free bend. All electrically MIG welded.

Frame Coating: Electrostatic powder coated application oven cured.

Hardware: All stainless steel hardware fasteners.

Dimensions: 8' portable picnic table walk-through design. Top is 30" wide x 96" long and is 30-1/2" high. Seats are 12" wide x 96" long and 18-1/2" high. Outside to outside dimension is 68-1/2" x 96".

COMPONENTS

Optional Surface Mount Hardware:
5/16" x 5" Concrete Expansion Anchor Bolts
(Not Included)

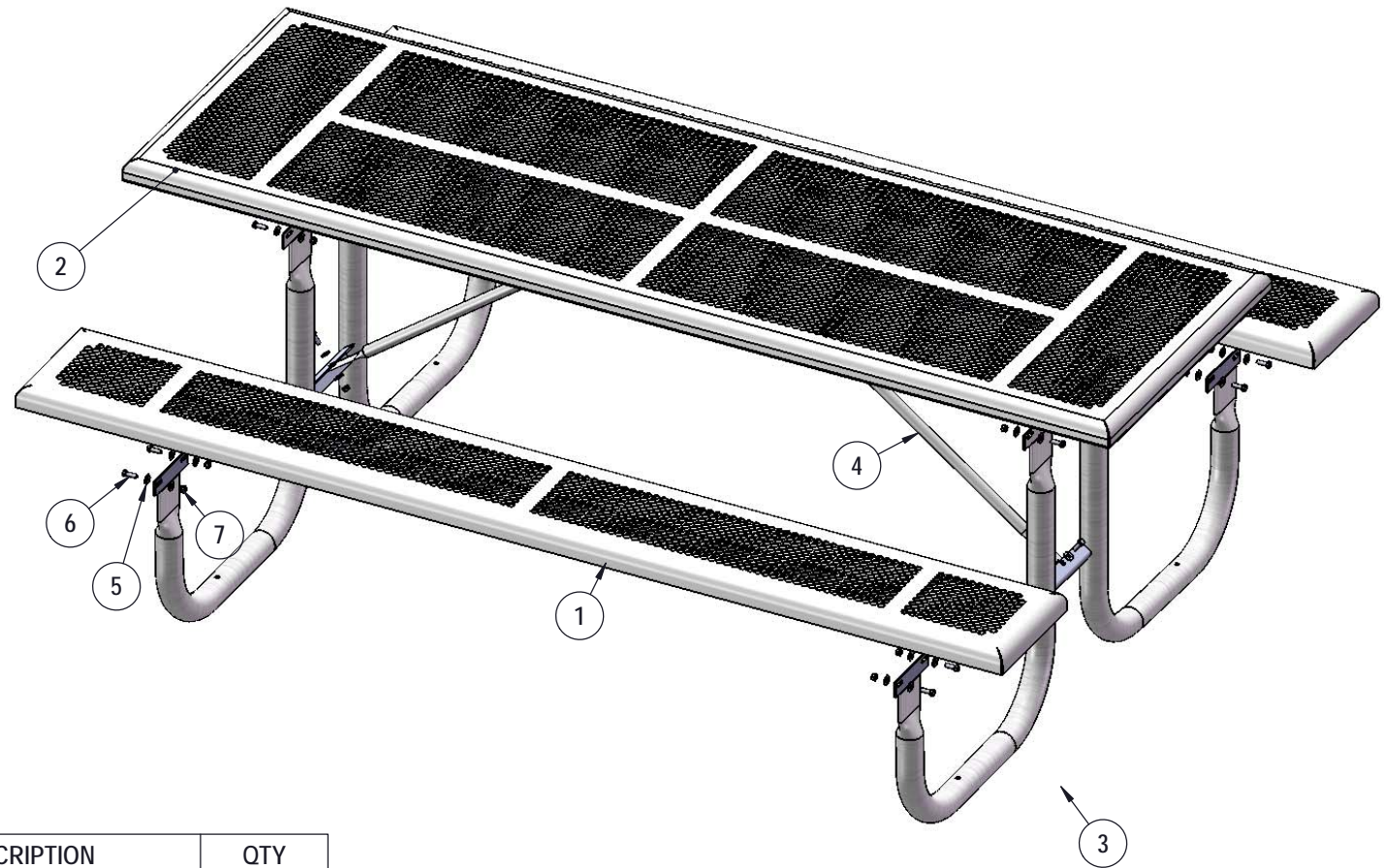

ITEM NO.	PartNo	DESCRIPTION	QTY
1	T-PR96-S	8' Punched Rolled Seat	2
2	T-PR96-T	8' Punched Rolled Top	1
3	P-V238	238 Vinyl Frame	2
4	P-01-04-0125	29 7/8" Brace	2
5	33-02-0007	5/16" SS Washer	40
6	33-05-0029	5/16" x 1" Machine Bolt (SS)	20
7	33-03-0012	5/16" Kep Nut (SS)	20

STEP 1

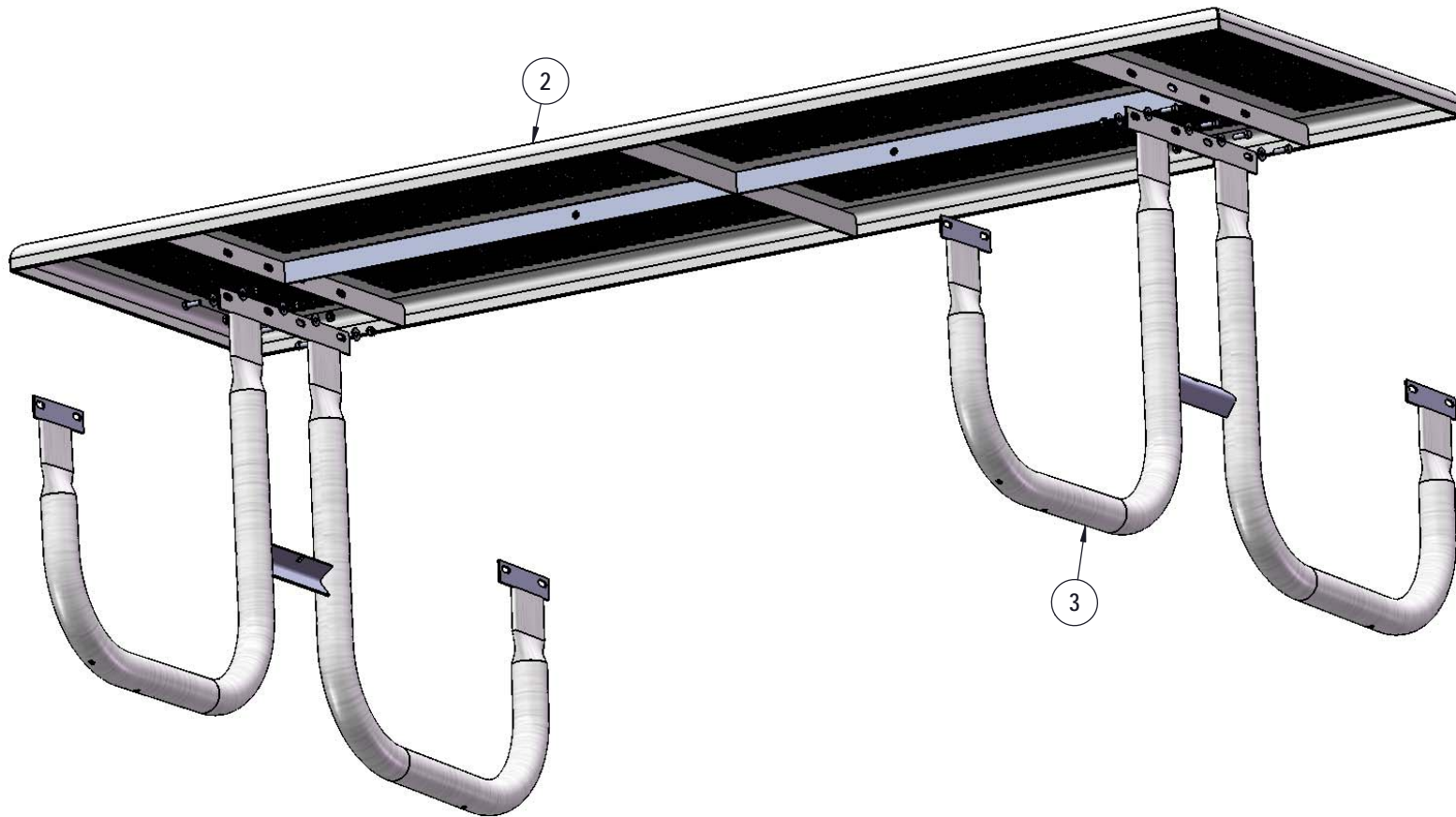

Attach the 8' Punched Rolled Top to the Frames using specified hardware.

STEP 2

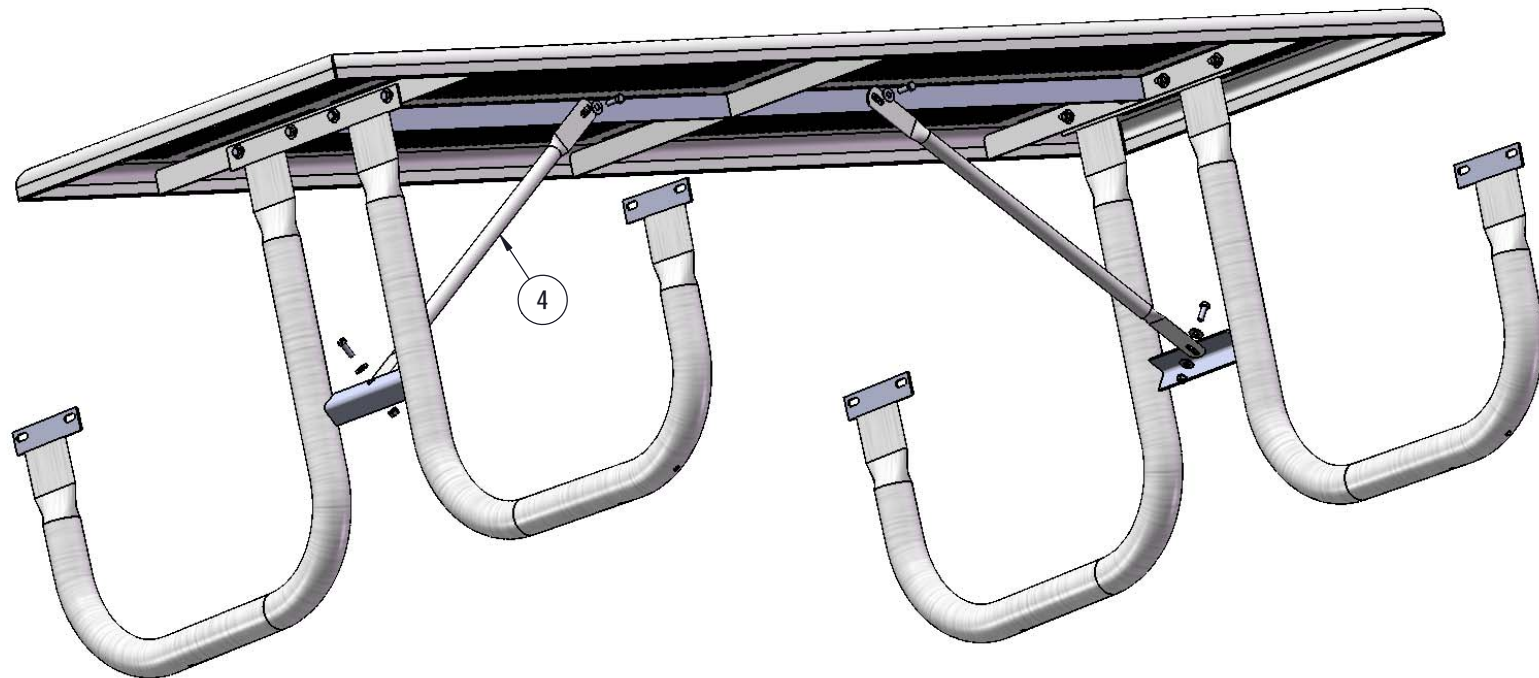

Attach the 29-7/8" Braces to the 8" Punched Rolled Top and the Frames as shown using specified hardware.

STEP 3

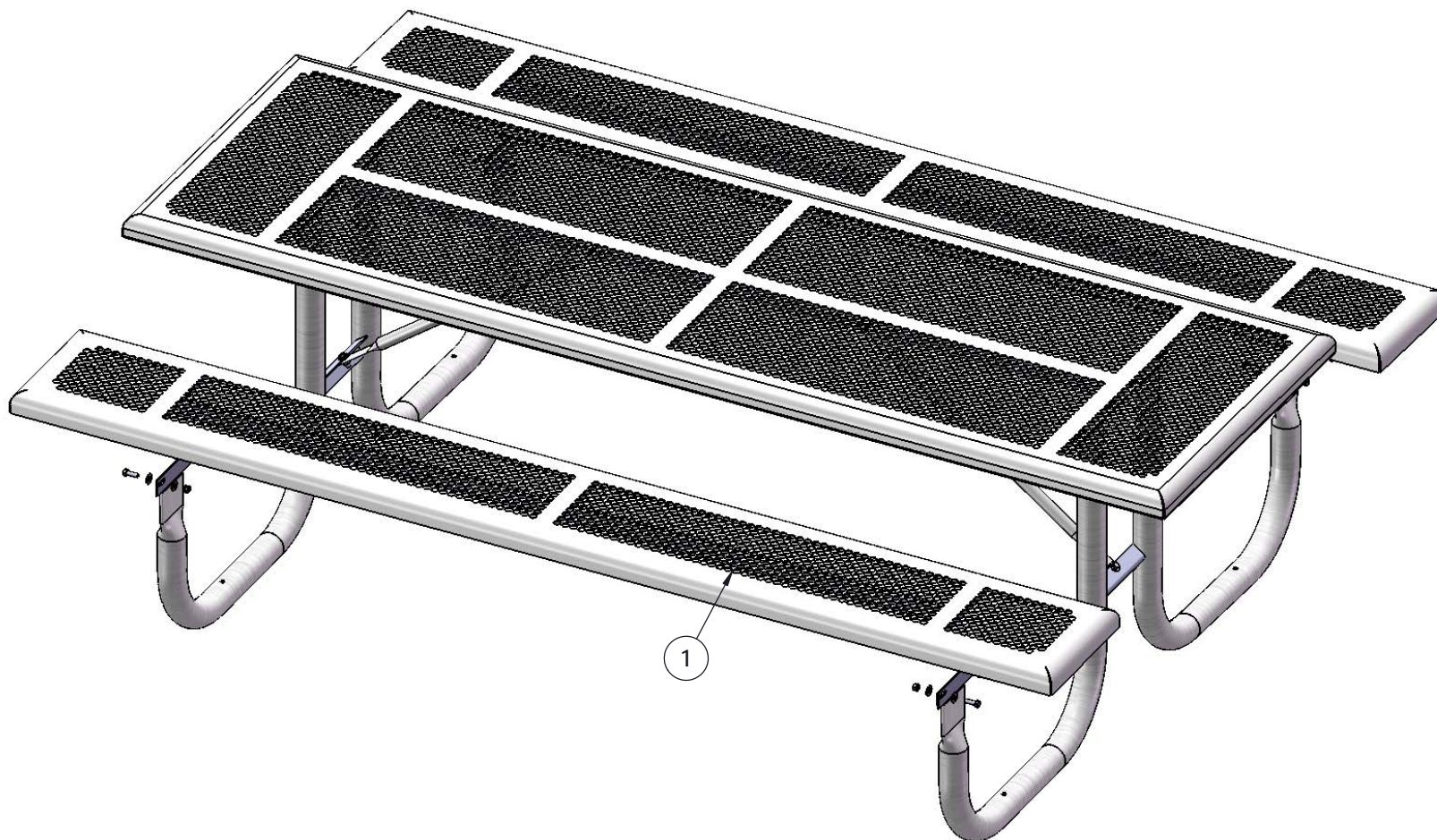

Attach the 8' Punched Rolled Seats to the Frames using specified hardware.

OVERALL DIMENSIONS

